

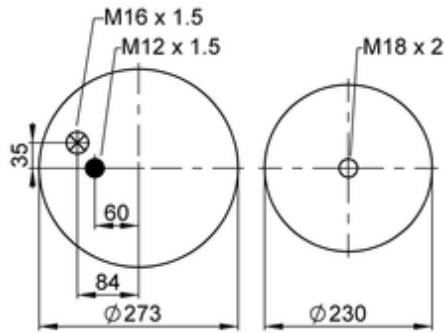

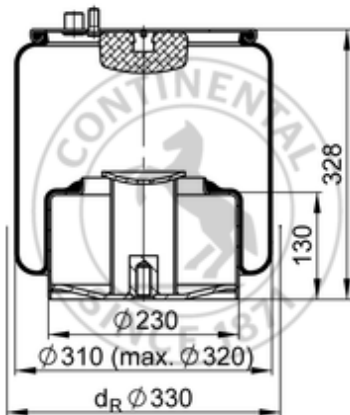









4705 N1 P04

76466



 bolt or stud
  hole
  combination stud
  air inlet
  stud and nut

| | |
|---|---------------------|
|  | 11,6 kg |
|  | 65637 |
|  | K032 |
|  | |
|  | M12x1.5: max. 40 Nm |
|  | M16x1.5: max. 20 Nm |
|  | M18x2: max. 180 Nm |

OE Manufacturer/Part No.

| Manufacturer | Original Part No. | Model |
|--------------|-------------------|------------------------|
| MAN | 81.43600.6040 | TGA ALV 11.5/7.5. 12/8 |
| MAN | 81.43600.6040 | TGA ALV 11.5/7.5. 12/8 |

