

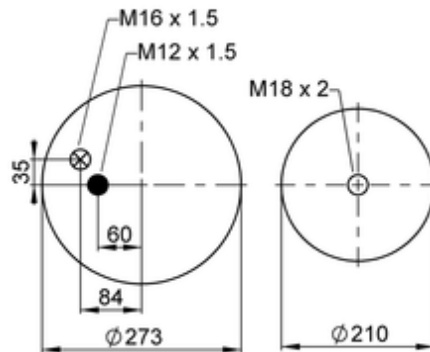

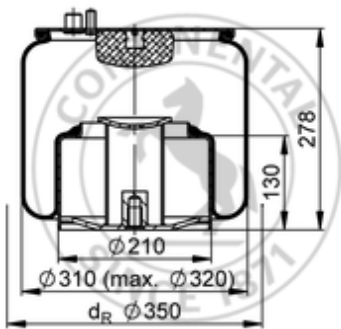









4916 N1 P07

76471



 bolt or stud   
  hole   
  combination stud   
  air inlet   
  stud and nut

	10,8 kg
	66169
	K034
	
	M12x1.5: max. 40 Nm
	M16x1.5: max. 40 Nm
	M18x2: max. 270 Nm

**OE Manufacturer/Part No.**

Manufacturer	Original Part No.	Model
MAN	81.43600.6042	TGA 13t axle
MAN	81.43600.6042	TGA 13t axle

