

FT 210-32

CONTI® Triple Convolution Air Spring

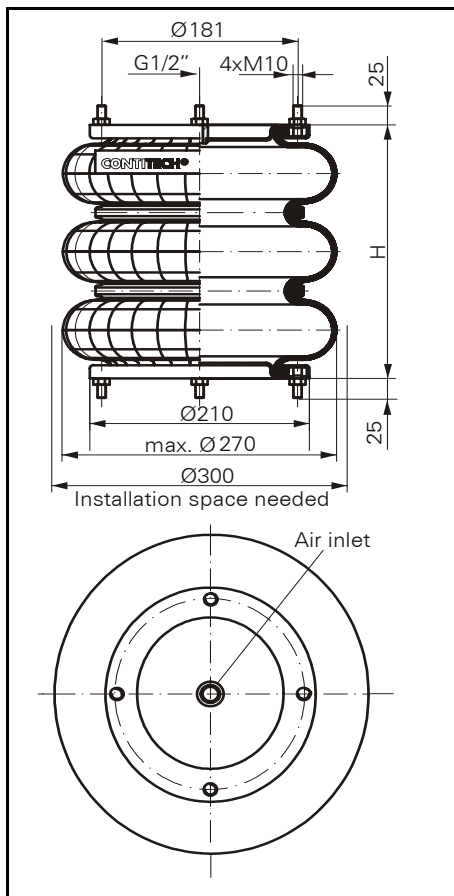

FT 210-32

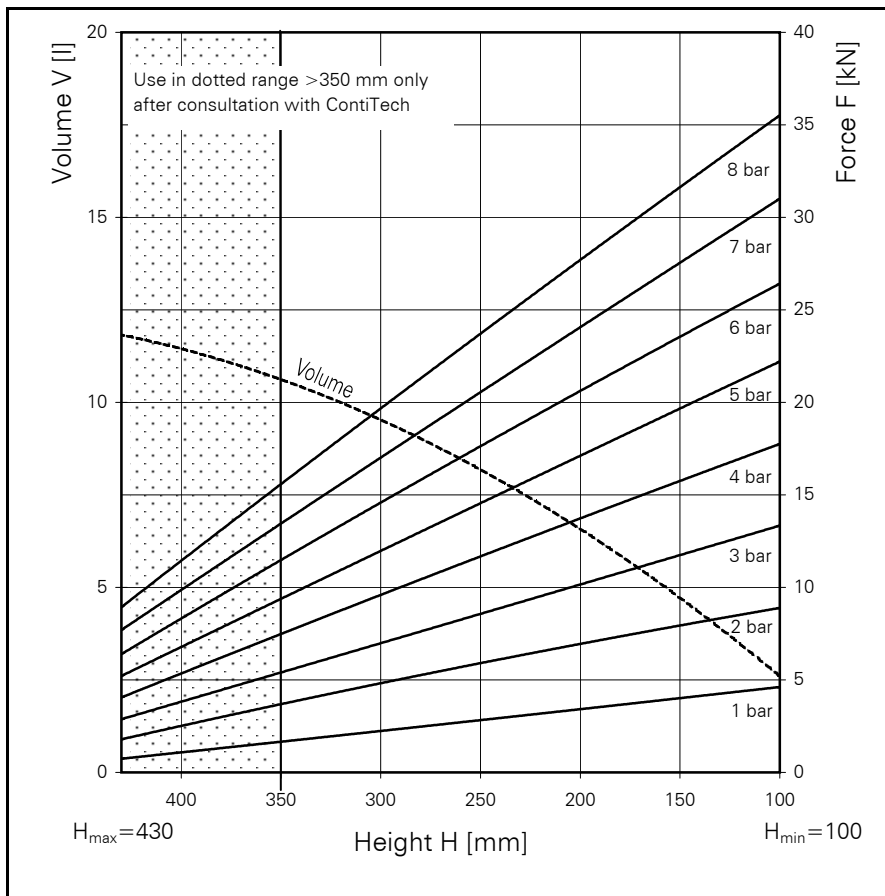

Force-height diagram

Purchase order data

Type	Order No.
Rubber bellows only	on request
With removable plates and G 1/2 air inlet	on request

Technical data

Min. pressure	0 bar
Return force to min. height	≤ 200 N
Overall weight with metal plates	5.6 kg

Additional types on request

Pneumatic application - static characteristic values

Force F [kN]

Pressure p [bar]	3	4	5	6	7	8	Vol.[l]	
Height H [mm]	350	5.4	7.5	9.5	11.5	13.4	15.5	10.6
	300	7.0	9.6	12.0	14.6	17.0	19.7	9.5
	250	8.5	11.7	14.5	17.6	20.5	23.7	8.2
	200	10.2	13.7	17.1	20.6	24.2	27.8	6.6
	150	11.8	15.7	19.7	23.6	27.5	31.6	4.7



Service instructions
M10 = 25 Nm
G 1/2 = 25 Nm