

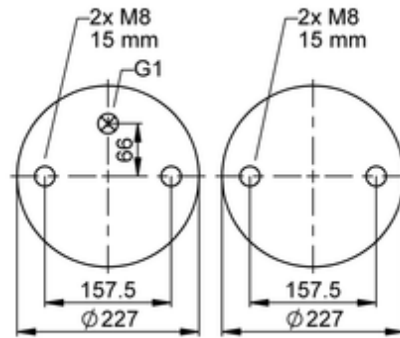

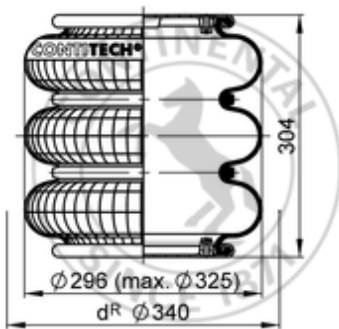





FT 330-29 1/1 M8

61830



-  bolt or stud
-  hole
-  combination stud
-  air inlet
-  stud and nut

 kg	5,5 kg
	G1/1: max. 50 Nm
	M8: max. 25 Nm

OE Manufacturer/Part No.

Manufacturer	Original Part No.	Model
--------------	-------------------	-------